

SLC

Developed by  
The Light Group

# SLC CLICK

LINEARE BELEUCHTUNGSSYSTEME

Installieren Sie ein  
lineares Beleuchtungssystem  
mit nur einem **CLICK!**





Die Eckverbindungen (X,T und L)  
sind durchgehend beleuchtet.



# REVOLUTIONÄR SCHNELLE INSTALLATION

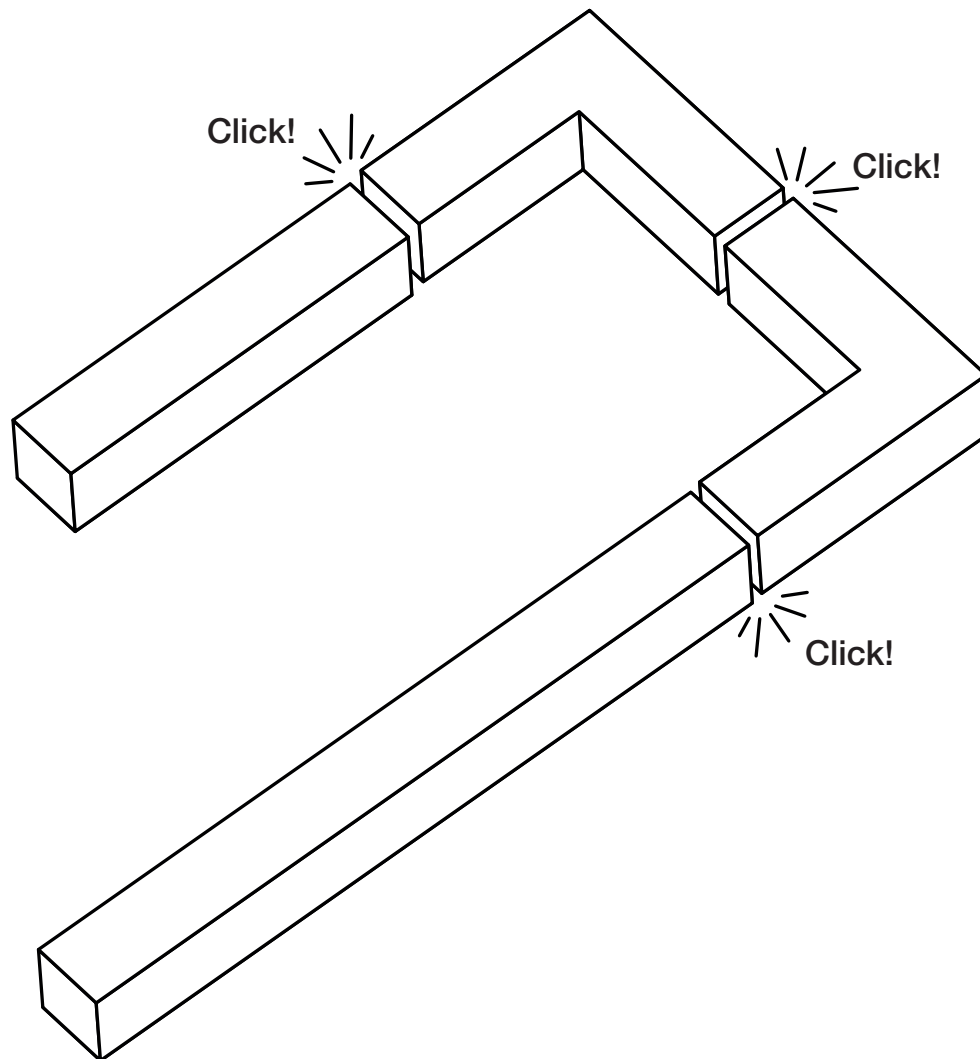

## SLC Click - Flexibles Linearsystem mit innovativer Schnellmontage

- Elektrischer und mechanischer Anschluss mit nur einem Klick
- Hervorragende Lichtausbeute mit geringer Blendung und hohem Wirkungsgrad
- DIP-Schalter zur Auswahl der Lichtfarbe in 3000K und 4000K bei allen Modulen
- Optionales Uplight als Zubehör erhältlich
- Dimmbar und DALI2 kompatibel
- Montage direkt an der Decke, abgehängt oder an der Wand
- Aluminium schwarz pulverbeschichtet RAL 9005, andere Farben auf Anfrage
- 5 Jahre Garantie

# EINZIGARTIGE FUNKTIONEN



L80B20  
100.000 Stunden

Revolutionäre Click-and-Play-Installation



Kein Streulicht

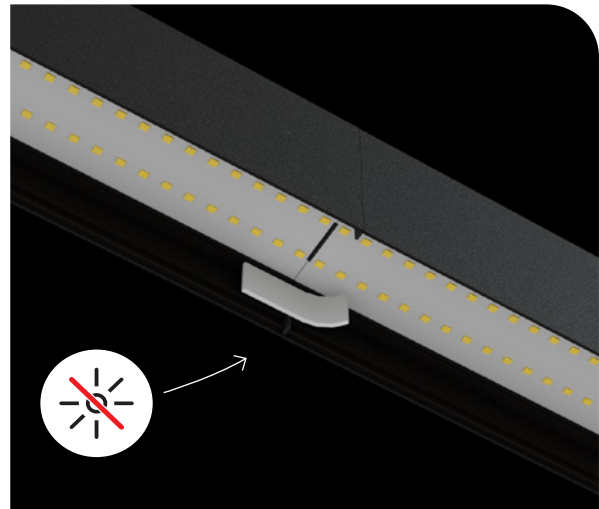

Oberlicht-Zubehör

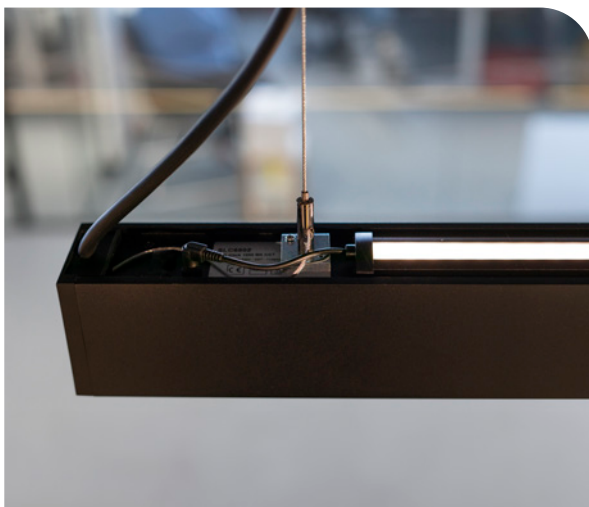

Einschieben - schnell anschließen



Anschlussfertige Büro-Sets  
mit "click-on" Dimmerknopf



Prismatische Abdeckungen  
für weiches Licht - 20m Rolle

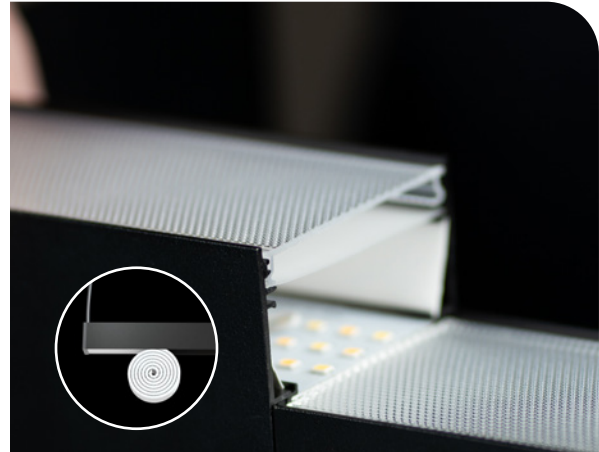

Bis zu 20m/600W  
pro Einspeisung

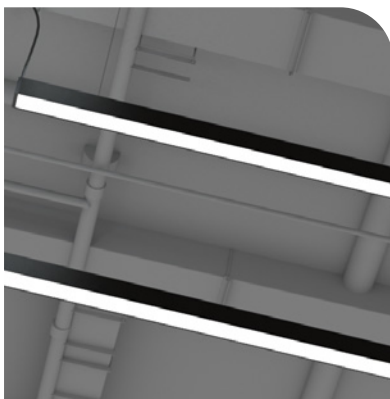

Doppel-Spot  
Schienen-Lichtmodul

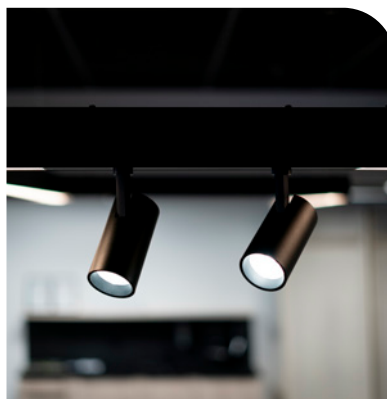

3000/4000 Kelvin  
DIP-Schalter



## Montage Optionen

Aufputz-Montage



Seilabhängung

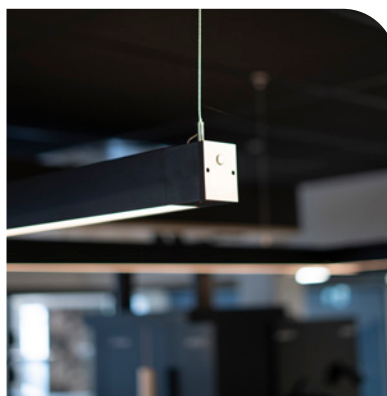

Wandmontage



# PRODUKTÜBERSICHT

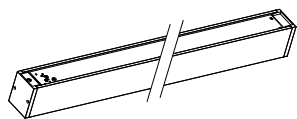

**Leuchte**  
SLC8500 560 CCT 18W  
SLC8502 1120 CCT 36W  
SLC8504 1400 CCT 45W



**Oberlicht Modul**  
SLC8506 560 CCT 5.5W  
SLC8508 1120 CCT 11W  
SLC8510 1400 CCT 13.5W

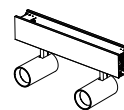

**Spot Modul 2 x 15W**  
SLC8535 400 30W

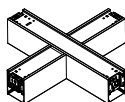

**X-Ecke**  
SLC8533 AC 18W

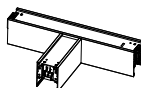

**T-Ecke**  
SLC8527 AC Links 14W  
SLC8529 AC Rechts 14W  
SLC8531 AC Mitte 14W

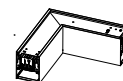

**L-Ecke (90°)**  
SLC8523 AC Rechts 10W  
SLC8525 AC Links 10W

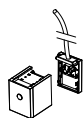

**Endkappe Pushdim + AC (3 adrig)**  
SLC8514 AC



**Endkappe**  
SLC8516



**Endkappe AC (5 adrig DALI)**  
SLC8512 AC

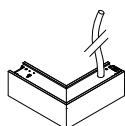

**L-Eck-Einspeisung (90°)**  
SLC8538 AC



**Verbindungsplatte**  
SLC8522



**Prismatische Abdeckung 20m Rolle**  
SLC8537

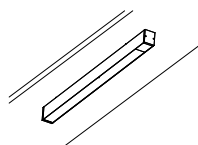

**Aufputz-Montage**  
SLC8519

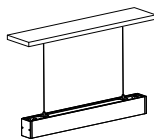

**Seilabhängung (1,5m)**  
SLC8518

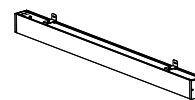

**Wandmontage**  
SLC8521



Die **L-Eck-Einspeisung** ist erforderlich, wenn ein quadratisches System installiert wird.

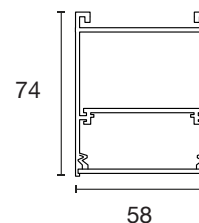

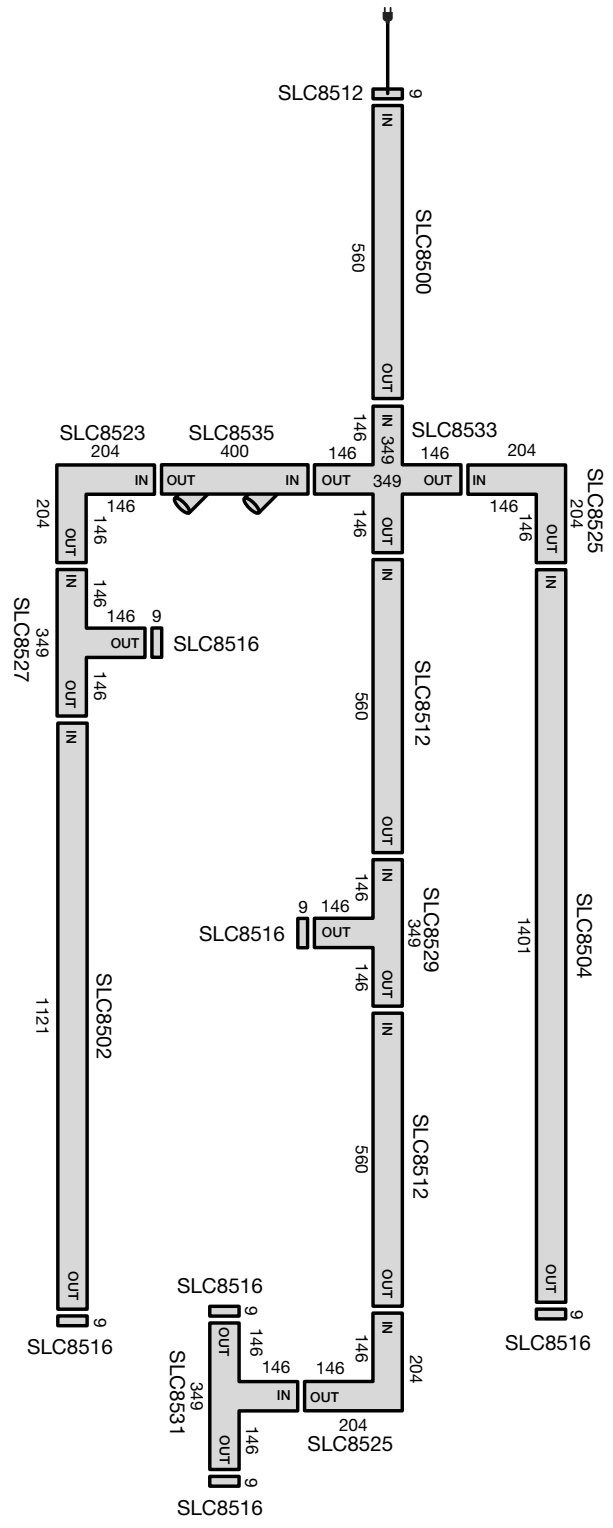
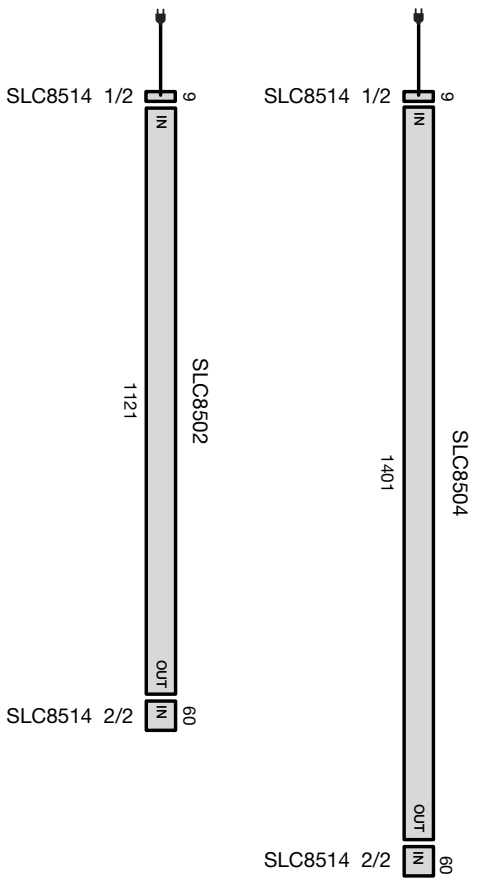
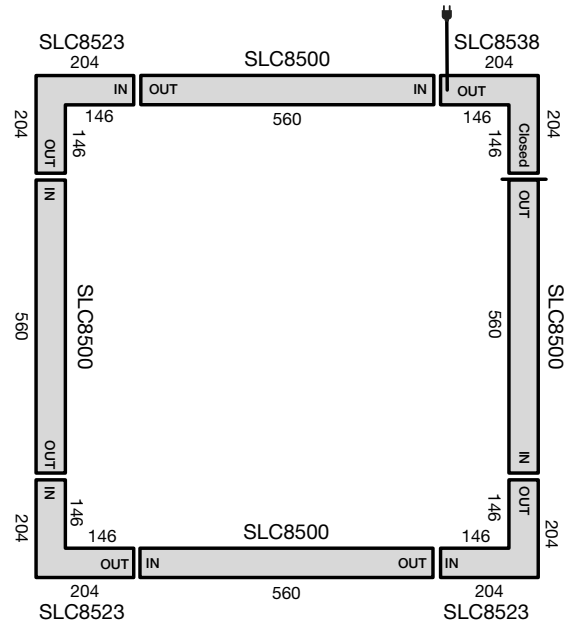

QR-Code scannen für Infos oder:  
[www.tlg.no/de/de/slc-click](http://www.tlg.no/de/de/slc-click)

